

Name: _____

Area of a Rectangle

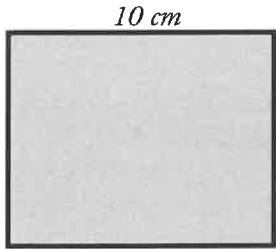

To find the area of a rectangle, use the formula **length x width = area**. This formula is often written as **$l \times w = A$** .

The rectangle pictured here has a length of 10 cm and a width of 8 cm.

$$l = 10 \text{ cm}$$

$$w = 8 \text{ cm}$$

$$10 \text{ cm} \times 8 \text{ cm} = 80 \text{ cm}^2$$

Note that the area's unit is written as cm^2 .

This is said as "square centimeters" or "centimeters squared".

Find the area of each rectangle.

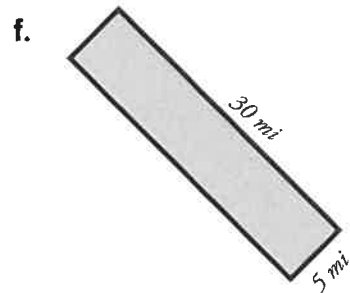
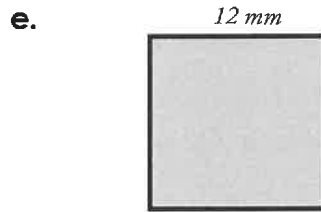
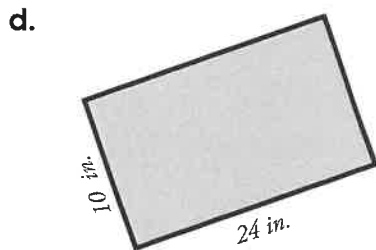
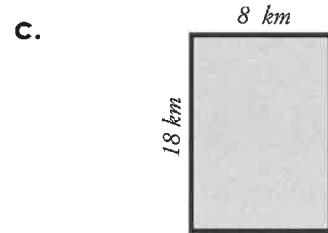
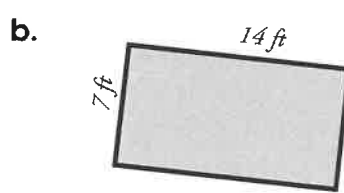
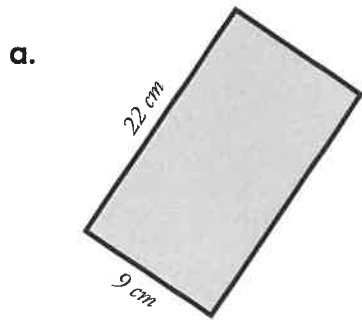

Challenge: Find the area of the polygon. All corners are 90° . Use the back if you need work space.

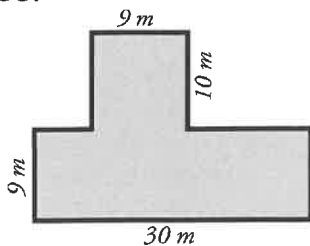

Name: _____

Perimeter of a Polygon

Find the perimeter of each shape by adding the lengths of each side.

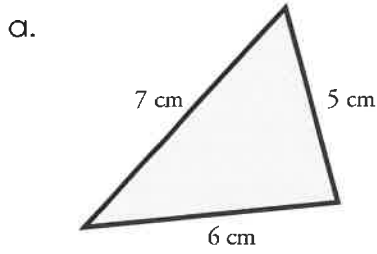

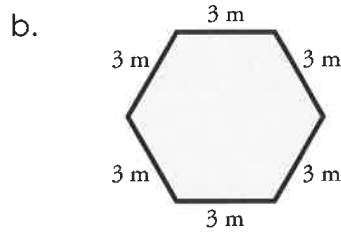

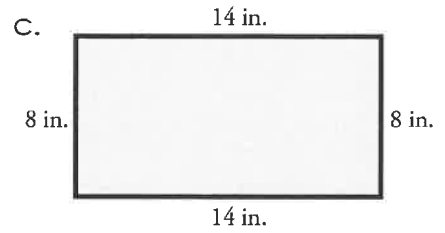

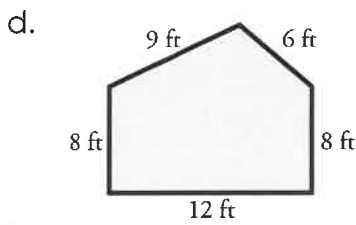

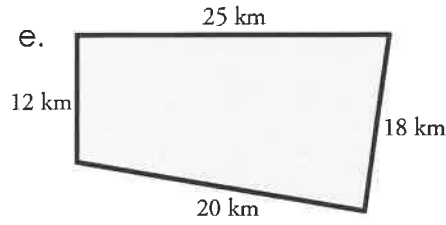

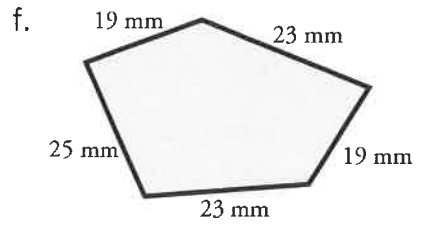

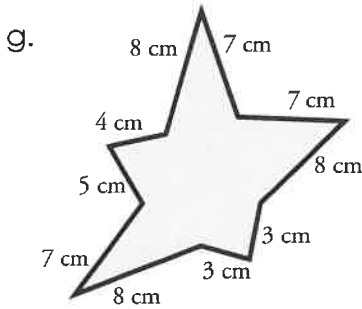

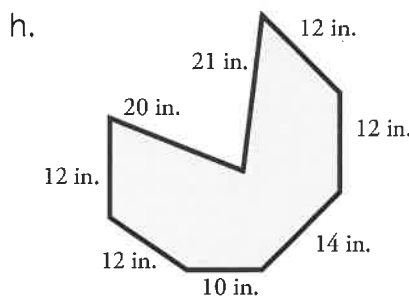

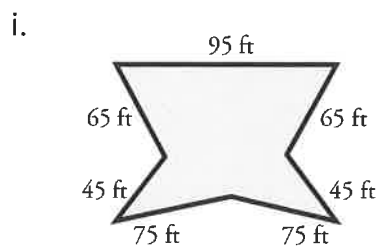

Challenge: Draw a square with a perimeter of 180 yards. Label the lengths of each side.

Name: _____

Types of Rocks

By Cindy Sherwood

Mount Rushmore is an amazing sight, with the faces of four presidents carved into a giant rock mountain. But even a small rock you find in your yard is pretty amazing. After all, most rocks have been around for millions of years. Some are billions of years old!

Rocks come in many sizes. A grain of sand can be considered a very tiny rock. Small, smooth rocks you can hold in your hand are called pebbles. A boulder is a very large rock that is detached, or separate from, other rocks. Some boulders are so big you can climb on them.

A scientist who studies rocks is called a geologist. Geologists will tell you that there are three main kinds of rocks on earth, and each kind started in a different way. The three types have long names that are a little difficult to say.

The first type of rock is igneous, which you pronounce "ig-knee-us." Igneous means "fire rocks," which is a good description of how they were formed. Most come from deep inside the earth's core where it is so hot that rocks are in a liquid form called magma. Magma that cools very slowly inside earth's crust creates one kind of igneous rock. Another kind of igneous rock forms after a volcano erupts. Liquid magma is called lava when it reaches the earth's surface and blasts out of a volcano. When the lava cools, it creates igneous rock.

About a quarter of the rocks on earth are igneous. The most common type is granite. Granite has big clumps of crystals that are either gray, white, pink, or red. Granite is often used

as a building material, and can be found in everything from kitchen counters to bridges. Another kind of igneous rock is obsidian, which you pronounce "ub-sid-ee-un." This is a shiny black volcanic rock with sharp edges that was often used for knife blades and arrowheads.

The second major type of rock is sedimentary, pronounced "said-uh-men-tare-ee." It means "sitting rock."

Igneous Rock



Sedimentary Rock



This type of rock is formed from igneous rocks that break down into smaller pieces and fall to the ground or to the bottom of a lake or river. After many years, layers of these tiny pieces of rock pile on top of one another. The layers eventually cement together to form sedimentary rock.

Sedimentary rock also can be created from the shells of tiny sea creatures that fall to the bottom of the ocean and get smashed together under the weight of the water. Sedimentary rocks formed close to the shore have mostly sand in them, such as sandstone. Sedimentary rocks formed farther from the shore have more clay in them, such as shale or limestone. Just as they did billions of years ago, sedimentary rocks still form in the same way today.

The third major type of rock is metamorphic, pronounced "met-uh-more-fic." Metamorphic means "changed form," and that is exactly what these rocks are. They start out as either igneous or sedimentary, but over time extreme heat or pressure causes them to change into a different kind of rock. For example, limestone eventually can turn into marble.

Metamorphic is the least common type of rock.

The next time you get a pebble in your shoe, take a minute to study it closely before you throw it away. That little pebble may be billions of years old. Maybe it came from a volcano, or maybe it traveled all the way from the center of the earth. Or maybe it was once part of the shell of a sea creature. Mount Rushmore is an amazing carved rock, but even the smallest, most ordinary rock is amazing, too!

Metamorphic Rock



Name: _____

Types of Rocks

By Cindy Sherwood

1. According to the information in the article, which of the following is **not** an example of a rock?

- a. a boulder in the woods
- b. a pebble inside your shoe
- c. a grain of sugar on the kitchen table
- d. a grain of sand on the seashore

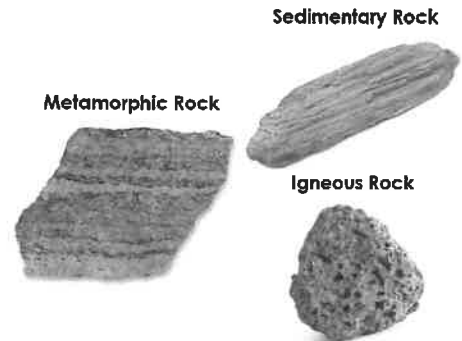

2. Based on what you read in the passage, what are two ways igneous rocks are formed?

1. _____
2. _____

3. Choose the best description of sedimentary rock from the choices below.

- a. Sedimentary rocks were formed under a lot of heat and pressure.
- b. Sedimentary rocks consist of layers of material cemented together.
- c. Granite and obsidian are two examples of sedimentary rock.
- d. Sedimentary rocks are the least common type of rock.

4. According to the article, what is magma?

5. Many everyday items we use are made out of rock. Based on what you learned in the article, place a check mark (✓) next to two common items made from rock.

- Granite counter tops
- Hardwood floors
- Window panes
- Knife blades

Name: _____

Types of Rocks

By Cindy Sherwood

Metamorphic Rock

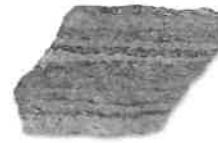

Sedimentary Rock



Igneous Rock



Match each vocabulary word from the reading passage with the correct definition.

- | | |
|---------------------------|--|
| _____ 1. crystals | a. a type of rock that forms from magma (inside the earth's crust) or lava (outside the earth's crust) |
| _____ 2. grain | b. shiny, black volcanic rock with sharp edges |
| _____ 3. core | c. a type of rock that is formed by layers of materials, such as shells, sand, or clay |
| _____ 4. volcano | d. solid objects that have naturally occurring geometric forms |
| _____ 5. igneous rock | e. U.S. National Memorial with the faces of four U.S. presidents carved into a huge rock |
| _____ 6. geologist | f. the center of the earth |
| _____ 7. sedimentary rock | g. a type of rock that undergoes changes because of heat and pressure |
| _____ 8. obsidian | h. very small particle |
| _____ 9. metamorphic rock | i. a mountain or hill with a crater in the center from which lava, gas, and rock pieces erupt |
| _____ 10. Mount Rushmore | j. a scientist who studies the earth, including rocks |

